

A

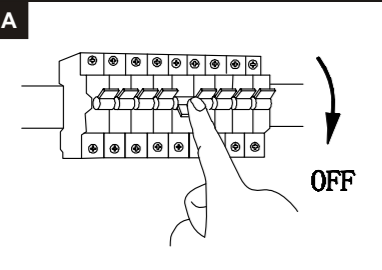

B

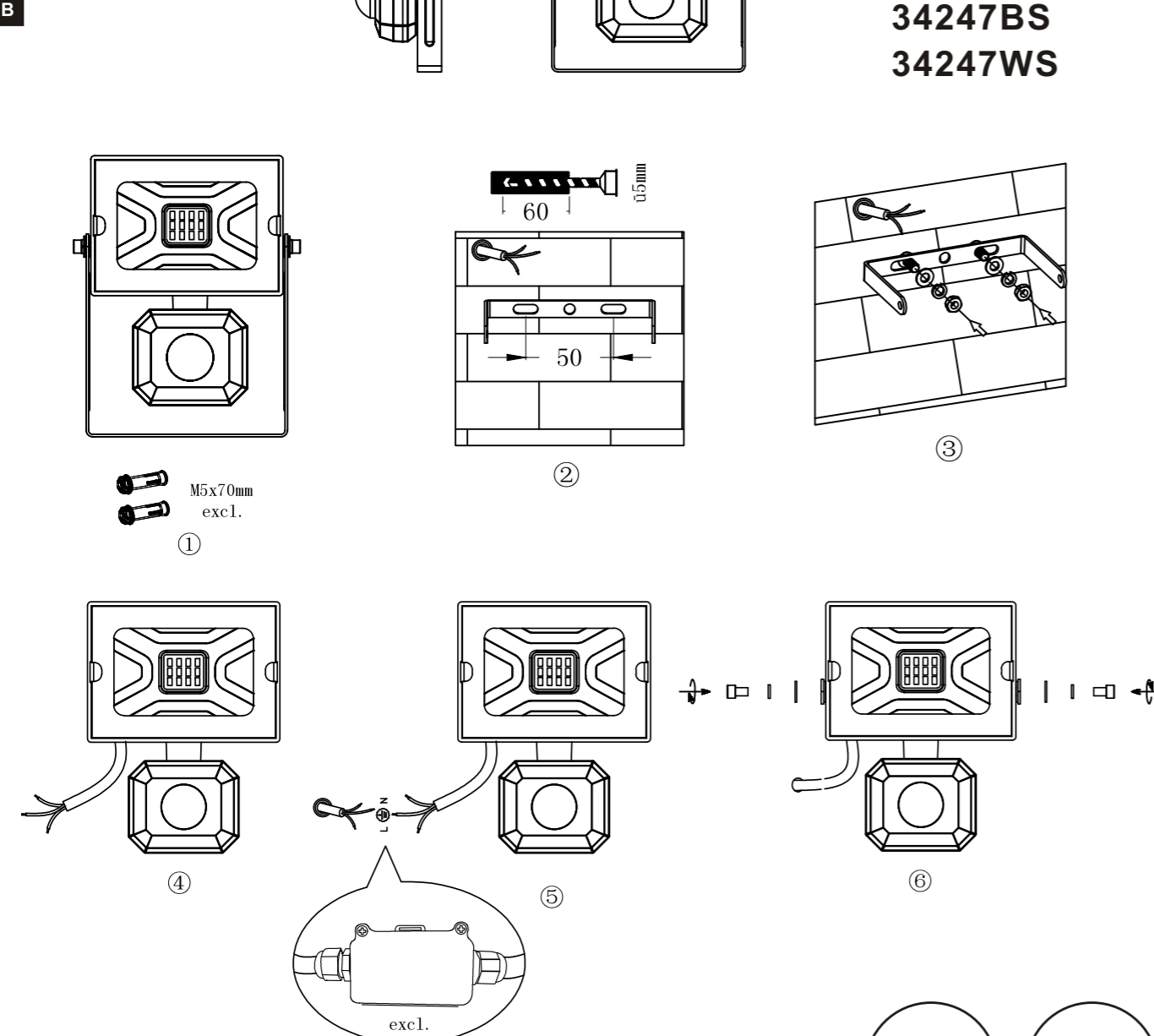

GLOBO
LIGHTING
www.globo-lighting.com

34247BS
34247WS

① M5x70mm
excl.

② 60 15mm

③

④

⑤

⑥

excl.

Sensor
incl.

IP44

GLOBO Handels GmbH
Gewerbstrasse 3
A-9184 Sankt Peter Austria

C

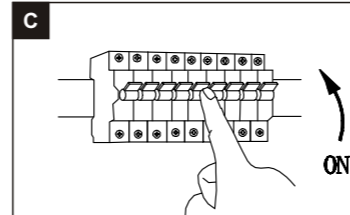

Lichtquelle/Light Source:

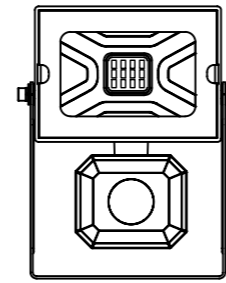

DEU:

Lichtquelle:

Die Lichtquelle ist nicht tauschbar, weil sie konstruktionsbedingt fest mit dem umgebenden Produkt verbunden ist.
Dieses Produkt enthält eine Lichtquelle der Energieeffizienzklasse <F>.

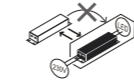

Das Betriebsgerät ist nicht austauschbar.



Die LED Lichtquelle ist nicht austauschbar.

GBR:

Light source:

The light source is not interchangeable because it is determined by the surrounding product design.
This product contains a light source of energy efficiency class <F>.

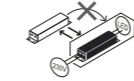

The control gear cannot be replaced.



The LED light source cannot be replaced.

BIH:

Izvor svjetla :

Izvor svjetla nije zamjenjiv , jer je konstrukcijski pričvršćen na proizvod .
Ovaj proizvod sadržava izvor svjetlosti klase energetske učinkovitosti <F>.

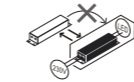

Pogonski uređaj se ne može zamjeniti .



LED – izvor svjetla nije moguće zamjeniti

BG:

Източник на светлина:

Източникът на светлина не може да се подменя, тъй като поради конструкцията си е трайно фиксиран към
заобикалящия го продукт.
Този продукт включва светлинен източник с клас на енергийна ефективност <F>.

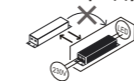

Устройството за управление не може да се подменя.



LED източникът на светлина не може да се подменя.

CZ:

Zdroj světla:

Světelný zdroj není možné vyměnit, protože je díky své konstrukci pevně spojený s produktem.
Tento výrobek obsahuje světelný zdroj s třídou energetické účinnosti <F>.

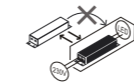

Předřadník není vyměnitelný.



Světelný zdroj není vyměnitelný.

DK:

Lyskilde:

Lyskilden kan ikke udskiftes, fordi den er fast forbundet med det omgivende produkt.
Dette produkt indeholder en lyskilde i energieffektivitetsklasse <F>.

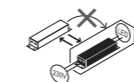

Driftsenheden kan ikke udskiftes.



LED lyskilden kan ikke udskiftes.

ET:

Valgusallikas:

Valgusallikas ei ole välja vahetatav, sest ta on tootega ehituslikult kindlalt seotud.
Toode sisaldab energiatõhususe klassi <F> valgusallikat.

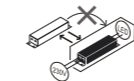

Juhtseadet ei saa asendada.



LED valgusallikat ei saa asendada.

FI:

Valonlähde:

Valonlähdettä ei voi vaihtaa uuteen, sillä se on rakenteellisesti yhdistetty ympäröivään tuotteeseen.
Tämä tuote sisältää valonlähteen, jonka energiatehokkuusluokka on <F>.

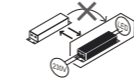

Liitäntälaitetta ei voi vaihtaa uuteen.



LED valonlähdettä ei voi vaihtaa uuteen.

FR:

Source lumineuse:

La source lumineuse n'est pas remplaçable car elle est, de par la construction du produit, liée de façon permanente à celui-ci.
Ce produit contient une source lumineuse de classe d'efficacité énergétique <F>.

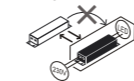



L'unité de contrôle n'est pas remplaçable.

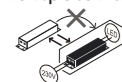

La source lumineuse LED n'est pas remplaçable.

GR:
Φωτεινή πηγή:
Η φωτεινή πηγή δεν μπορεί να αντικατασταθεί, επειδή είναι για κατασκευαστικούς λόγους σταθερά συνδεδεμένη με το προϊόν που την περιβάλλει.
Το προϊόν αυτό περιέχει φωτεινή πηγή της τάξης ενεργειακής απόδοσης <F>.

 Η λειτουργική συσκευή δεν αντικαθίσταται.

  Η φωτεινή πηγή LED δεν αντικαθίσταται.



HU:
Fényforrás:
A fényforrás nem cserélhető, mert felépítése miatt szilárdan csatlakozik a termékhez.
Ez a termék egy <F> energiahatékonysági osztályú fényforrást tartalmaz.

 Az előtét nem cserélhető.

  A fényforrás nem cserélhető.

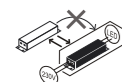

Isländisch/IS:
Ljósgrjafi:
Ljósgrjafinn er ekki útskiptanlegur vegna þess að hann er háður umliggjandi hönnun vörunnar.
Varan inniheldur ljósgrjafa í orkuflokki <F>.

 Ekki er hægt að skipta um stjórnbúnaðinn.

  Ekki er hægt að skipta um LED ljósgrjafann.

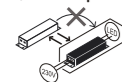

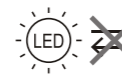
IT:
Sorgente luminosa:
La sorgente luminosa non è intercambiabile perché è saldamente collegata al prodotto per via del suo design.
Questo prodotto contiene una sorgente luminosa di classe di efficienza energetica <F>.

 La centralina non può essere sostituita.

  La sorgente luminosa a LED non può essere sostituita.

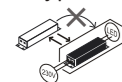

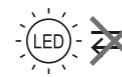
HR:
Izvor svjetla:
Izvor svjetla nije zamjenjiv, jer je konstrukcijski pričvršćen na proizvod.
Ovaj proizvod sadržava izvor svjetlosti klase energetske učinkovitosti <F>.

 Pogonski uređaj se ne može zamjeniti.

  LED – izvor svjetla nije moguće zamjeniti.

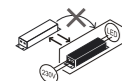
LV:
Gaismas avots:
Gaismas avotu nevar nomainīt, jo tas konstrukcijā ir cieši savienots ar izstrādājuma apkārtējo daļu.
Šis ražojums satur gaismas avotu, kura energoefektivitātes klase ir <F>.

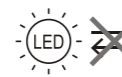
 Vadības ierīci nevar nomainīt.

  LED apgaismes līdzekli nevar nomainīt.

LT:
Šviesos šaltinis:
Šis šviesos šaltinis yra nekeičiamas, nes jis prijungtas prie gaminio pagal jo konstrukciją.
Šiame gaminyje yra šviesos šaltinis, kurio energijos vartojimo efektyvumo klasė <F>.

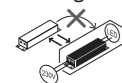
 Valdymo įtaisas yra nekeičiamas.

  LED šviesos šaltinis yra nekeičiamas.



NL:
Lichtbron:
De lichtbron kan niet worden vervangen, omdat deze vanwege de constructie vast met het product eromheen verbonden is.
Dit product bevat een lichtbron van energie efficiëntieklasse <F>.

 Het apparaat kan niet worden vervangen.

  De LED lichtbron kan niet worden vervangen.

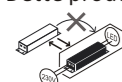

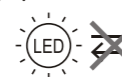
Norwegisch/Norwegian/ NO:
Lyskilde:
Lyskilden kan ikke byttes fordi den sitter fast i produktet.
Dette produktet inneholder en lyskilde i energiklasse <F>.

 Driverenheten kan ikke byttes.

  LED lyspæren kan ikke byttes.

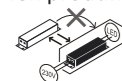

PL:
Źródło światła:
Źródła światła nie można wymienić, ponieważ jest zintegrowane z produktem ze względu na swoją konstrukcję.
Ten produkt zawiera źródło światła o klasie efektywności energetycznej <F>.

 Nie można wymienić przekładni sterującej.

  LED źródło światła nie może być wymienione.



PT:
Fonte de Luz:
A fonte de luz não é substituível porque devido às suas características construtivas está fixada de forma permanente ao produto circundante.
Este produto contém uma fonte de luz da classe de eficiência energética <F>.

 Equipamento de controlo não substituível.

  Lâmpada não substituível.

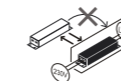
RO:
Sursa de lumina:
Sursa de lumina nu este inlocuibila ea fiind parte constructiva a produsului.
Acest produs conține o sursă de lumină cu clasa de eficiență energetică <F>.

 Driverul nu poate fi inlocuit.

  Sursa de lumina nu poate fi inlocuita.

RUS:
Источник света:
Источник света не является взаимозаменяемым, поскольку это определяется конструкцией смежного продукта.
Данный продукт содержит источник света класса энергоэффективности <F>.

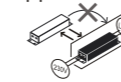
 Устройство управления не подлежит замене.

  Светодиодный источник света не подлежит замене.

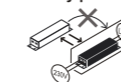

SRB:
Izvor svetlosti:
Izvor svetlosti nije zamenljiv, jer je zbog svog dizajna čvrsto povezan sa proizvodom koji ga opkružuje.
Ovaj proizvod sadrži izvor svetlosti klase energetske efikasnosti <F>.

 Upravljački uređaj nije zamenljiv.

  LED izvor svetlosti nije zamenljiv.

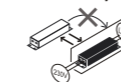
SK:
Zdroj svetla:
Svetelný zdroj nie je možné vymeniť, pretože je vďaka svojej konštrukcii pevne spojený s produktom.
Tento výrobok obsahuje svetelný zdroj triedy energetickej účinnosti <F>.

 Predradník nie je vymeniteľný.

  Svetelný zdroj nie je vymeniteľný.



SI:
Izvor svetlobe:
Vir svetlobe ni zamenljiv, ker je določen z zasnovano izdelka v okolici.
Ta izdelek vsebuje svetlobni vir razreda energijske učinkovitosti <F>.

 Krmilnik ni mogoče zamenjati.

  Svetlobni vir ni mogoče zamenjati.

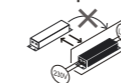
ES:
Fuente de luz:
La fuente de luz no es sustituible porque está fija en el producto desde la construcción.
Este producto contiene una fuente luminosa de la clase de eficiencia energética <F>.

 Dispositivo de control no reemplazable.

  Bombilla no reemplazable.

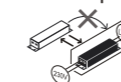

SE:
Ljuskälla:
Ljuskällan är inte utbytbar, eftersom den på grund av konstruktionen är fast integrerad i den omgivande produkten.
Denna produkt innehåller en ljuskälla med energieffektivitetsklass <F>.

 Driftdonet kan inte bytas ut.

  LED ljuskällan kan inte bytas ut.

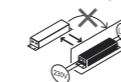

TR:
Işık kaynağı:
Konstrüksiyon gereği çevreleyen ürün ile sabit bir şekilde bağlı olduğu için ışık kaynağı değiştirilemez.
Bu ürün, <F> enerji sınıfından bir ışık kaynağına sahiptir.

 İşletme cihazı değiştirilemez.

  LED ışık kaynağı değiştirilemez.

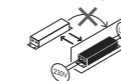
UK:
Джерело світла:
Джерело світла не можна обміняти, оскільки воно міцно пов'язане з навколишнім виробом завдяки своїй конструкції.
Цей виріб містить джерело світла класу енергоефективності <F>.

 пристрій керування не можна замінювати.

  джерело світлодіодного світла не можна замінювати.